

# ASSEMBLY INSTRUCTIONS

## RHODES DINING CHAIR

Please read instructions carefully. Remove all wrapping material and packing from the carton. See hardware and furniture parts list for guidance. Be sure you have all parts before you start to assemble the product. Place all furniture parts on a clean surface, such as carpet or rug to prevent the item from being scratched.

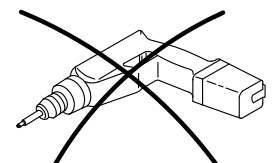
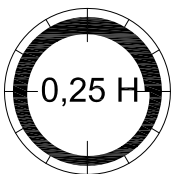
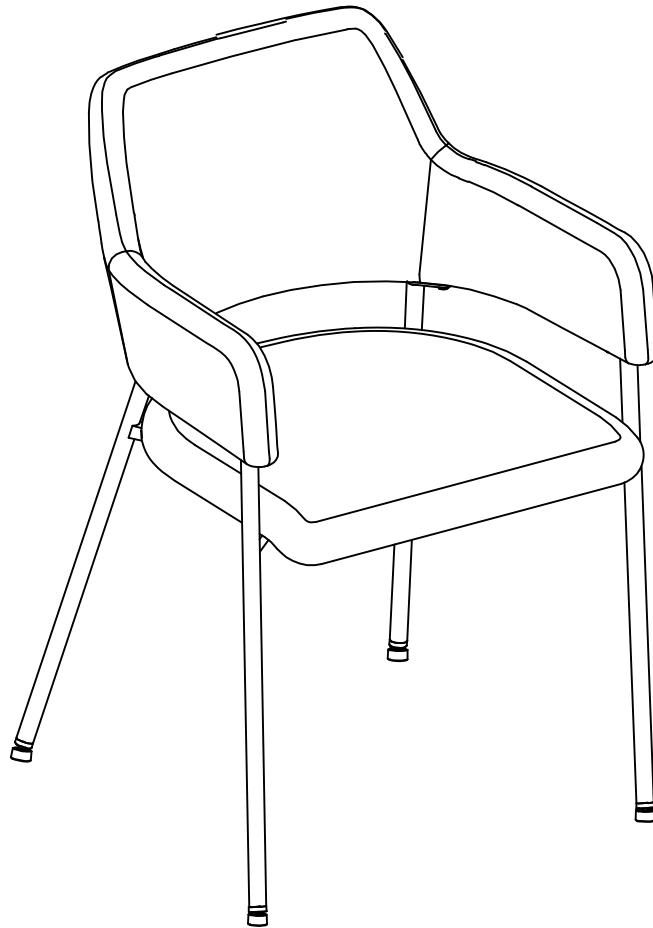

Part list:

1 x Part 1

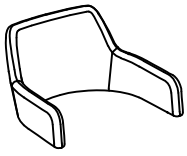

Back

1 x Part 2



Seat

1 x Part 3



Leg Back

1 x Part 4

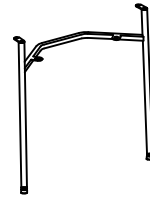

Leg Front

Hardware list:

Ax4



Bolt  
M6x16

Bx4



Bolt  
M6x16

Cx2

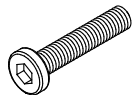

Bolt  
M6x30

Dx4

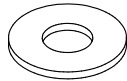

Washer  
Ø6/Ø18

Ex2



Spring washer  
Ø6

Fx1

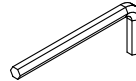

Allen key  
4mm



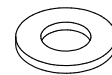

Gx2

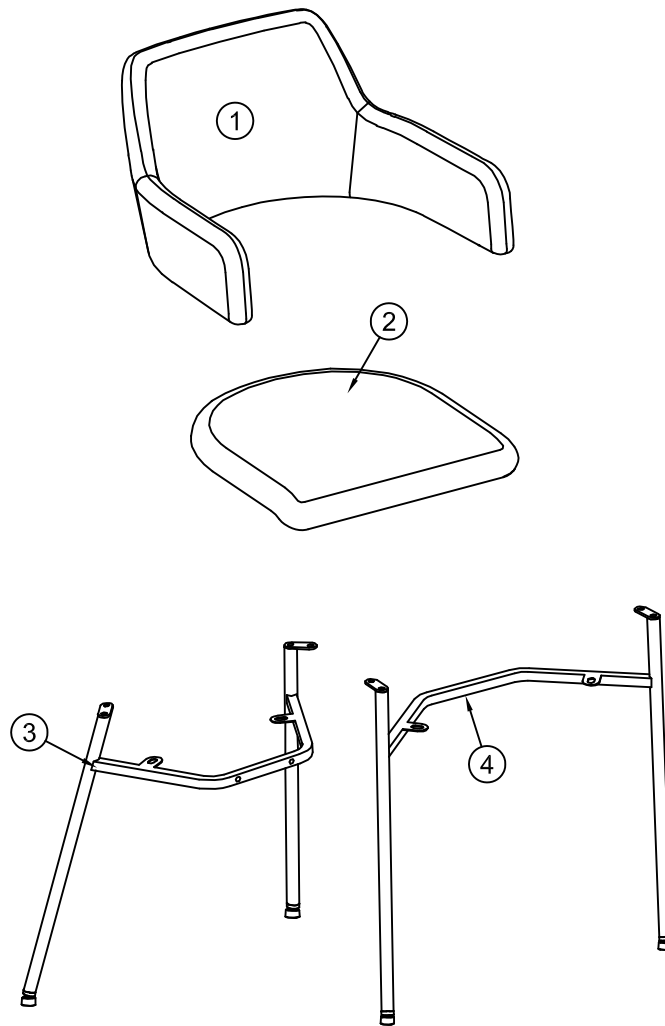

Washer  
Ø6/Ø14

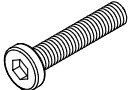

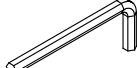

1

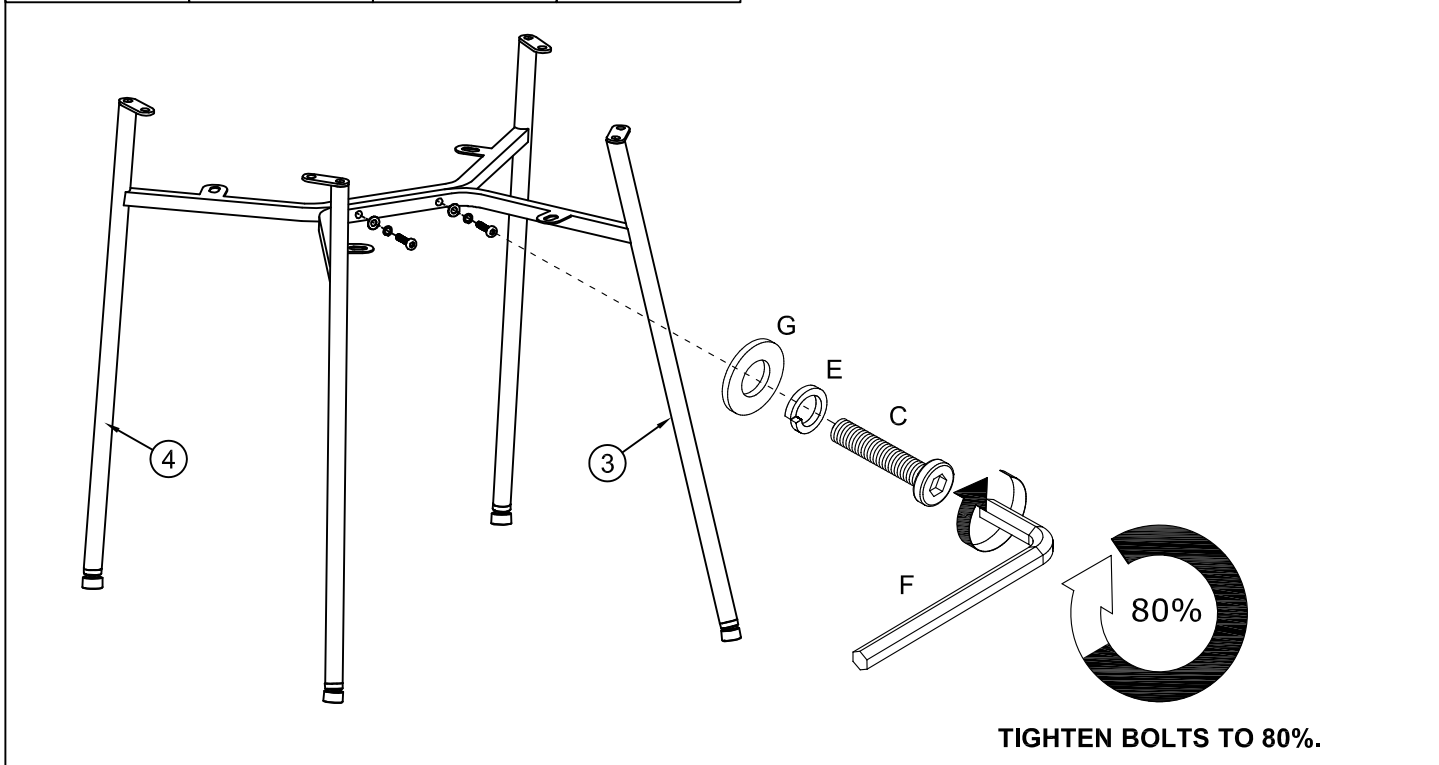
Cx2  M6x30mm	Ex2  Ø6mm	Fx1  4mm	Gx2  Ø6/Ø14mm
---	--	---	--

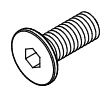

2

Bx4  M6x16mm	Fx1  4mm
---	---

